



Inspired by the legendary 1970s, Denver is a combination of perfectly balanced shapes, whose design is clearly visible from the side. Each module is composed of two elements: the main body with a full shape that rests on the ground and the seat cushion coming out of the body itself. It is available in leather or fabric. Three units with different depths and widths, can be combined to create an infinite number of compositions able to meet space requirements and comfort expectations.

Dimensions

DENVER . 88 . 112

Modular element

88 W x 112 D x 78 H cm

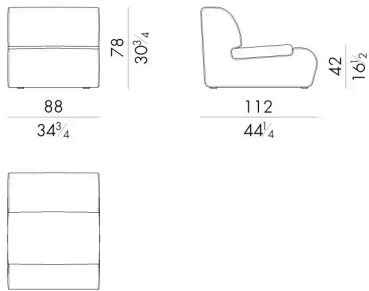

DENVER . 112 . 112

Modular element

112 W x 112 D x 78 H cm

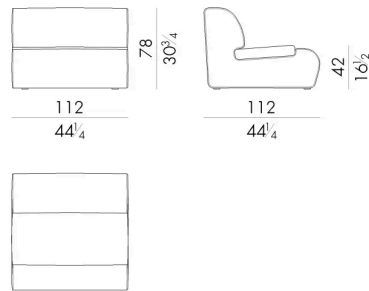

DENVER . 112 . 145

Modular element

112 W x 152 D x 78 H cm

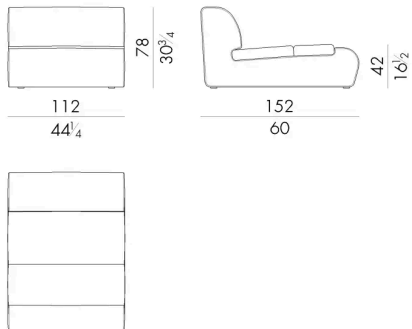

DENVER . 128 . 145

Modular element

128 W x 152 D x 78 H cm

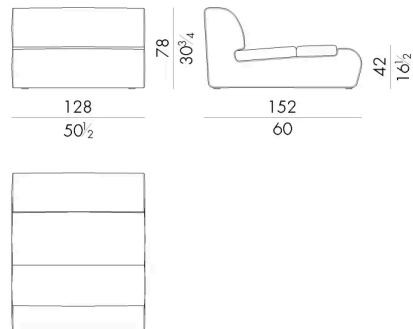

DENVER. 2300

Modular sofa

264 W x 112 D x 78 H cm

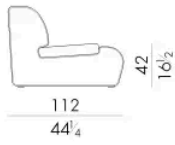
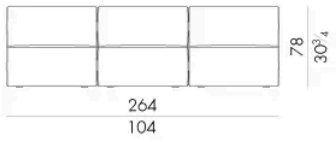

DENVER. 2400

Modular sofa

336 W x 112 D x 78 H cm

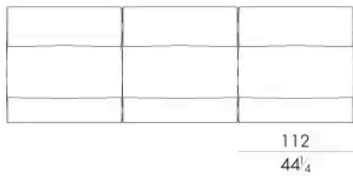
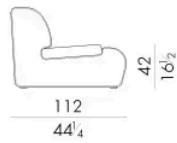
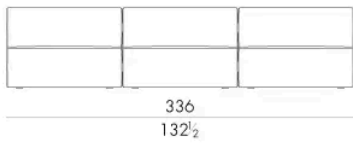

DENVER. 2700 / DX

Modular sofa

376 W x 112/152 D x 78 H cm

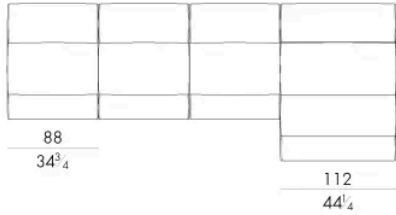
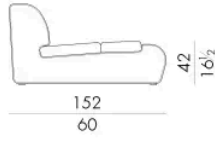
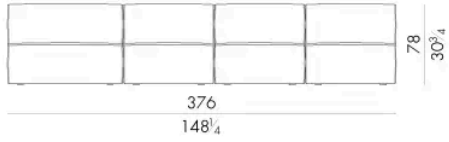

DENVER. 2700 / SX

Modular sofa

376 W x 112/152 D x 78 H cm

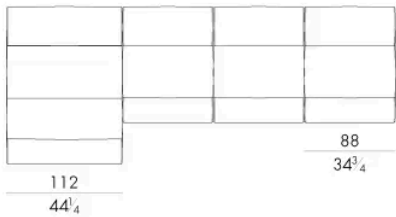
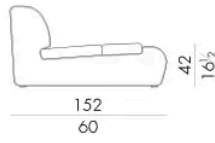
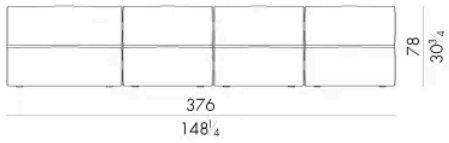

DENVER. 2800 / DX

Modular sofa

480 W x 112/152 D x 78 H cm

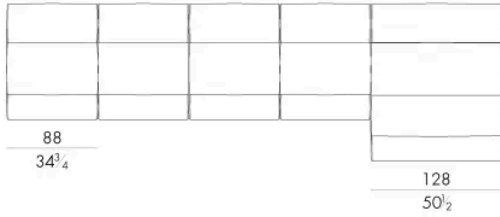
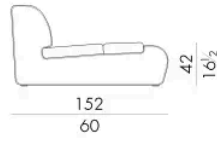
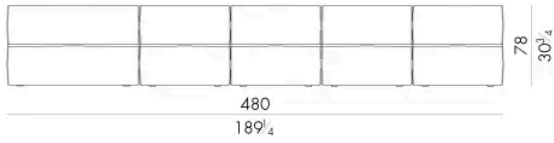

DENVER. 2800 / SX

Modular sofa

480 W x 112/152 D x 78 H cm

